

Control panel design guide



UL 508A control panel design guide

The easy-to-design guide for selection of electrical control components in control panels used in industrial machinery applications

This guide is provided to assist with the design of control panels per UL® 508A, specifically for use in industrial machinery applications. This guide is designed to cover the most common applications of electrical control products per UL 508A, but is by no means an exhaustive guide, and does not cover all uses and applications associated with UL 508A regulations. This guide is not intended to be used in lieu of UL 508A or other regulatory standards. Always consult all pertinent actual regulatory standards and local standard representatives to ensure full compliance.

EATON
Powering Business Worldwide

 Farnell  element14

Designing the panel

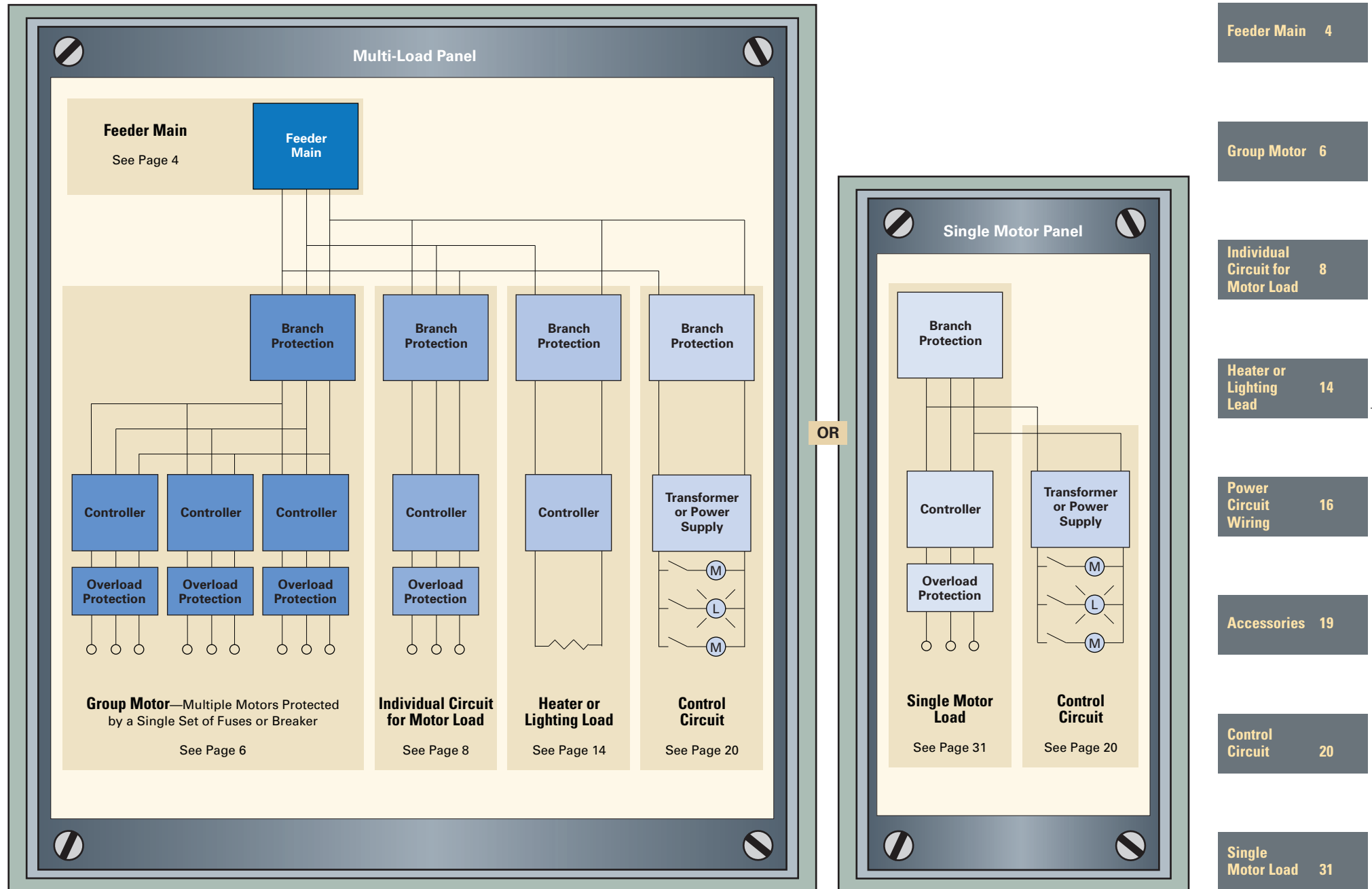

Sizing the feeder

The feeder amp rating is sized based on the sum of the amp rating of the largest branch protective device plus the full-load currents of the other loads.

In this example, the 125A circuit breaker is the largest short-circuit protective device. This value is added to the full load currents of the other loads in the circuit (motors, heater, and the primary of the transformer).

The overcurrent feeder amp rating should not exceed the conductor ampacity rating on the loadside. For conductor ampacity ratings, see Table 28.1 on Page 18.

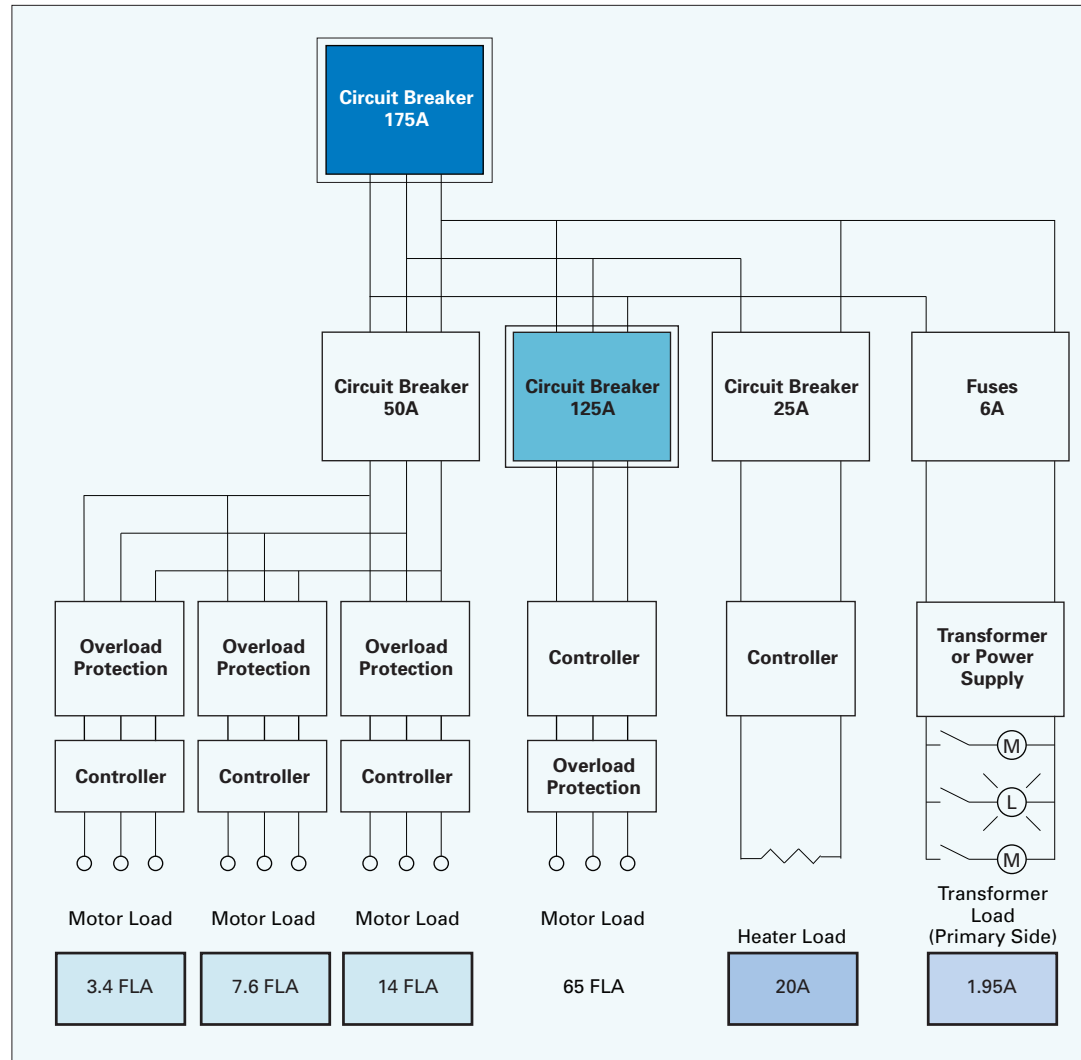

Example Multi-Load Panel

$$125A + 3.4A + 7.6A + 14A + 20A + 2A = 172A$$

Use closest size, 175A

Breaker and Fused Disconnect Selection

Molded Case Circuit Breaker



EG Frame



NEMA 1/12/3R Rotary Handle Mechanism, 12" Shaft for EG **EGHMVD12B**



JG Frame



NEMA 1/12/3R Rotary Handle Mechanism, 12" Shaft for JG **JGHMVD12B**



LG Frame



NEMA 1/12/3R Rotary Handle Mechanism, 12" Shaft for LG **LGHMVD12B**

Rotary Fusible Disconnect (Fuses not Included)

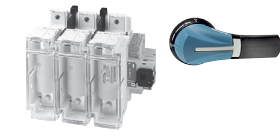
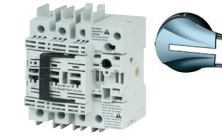

Target Ampacity	Breaker Frame	18 kA 480V 25 kA 240V	25 kA 480V 65 kA 240V	25 kA 480V 35 kA 240V	35 kA 480V 65 kA 240V	65 kA 480V 100 kA 240V	65 kA 480V 100 kA 240V	100 kA 480V 200 kA 240V	100 kA @ 600V with Class J	200 kA 600V with Class J
1	EG	EGB3015FFG	—	EGE3015FFG	—	EGH3015FFG	—	EGC3015FFG	Base R4H3030FJ NEMA 1, 3R, 12 handle PHB1N12F 12" shaft SF320PH5X5 Fuse type Class J Integrated lugs #14-#10	Base R9J3030FJ NEMA 4X handle PHB1N4XF 12" shaft SF320PH10X10 Fuse type Class J Terminal lugs #10-#6
3	EG	EGB3015FFG	—	EGE3015FFG	—	EGH3015FFG	—	EGC3015FFG		
6	EG	EGB3015FFG	—	EGE3015FFG	—	EGH3015FFG	—	EGC3015FFG		
10	EG	EGB3015FFG	—	EGE3015FFG	—	EGH3015FFG	—	EGC3015FFG		
15	EG	EGB3015FFG	—	EGE3015FFG	—	EGH3015FFG	—	EGC3015FFG		
20	EG	EGB3020FFG	—	EGE3020FFG	—	EGH3020FFG	—	EGC3020FFG		
25	EG	EGB3025FFG	—	EGE3025FFG	—	EGH3025FFG	—	EGC3025FFG		
30	EG	EGB3030FFG	—	EGE3030FFG	—	EGH3030FFG	—	EGC3030FFG		
35	EG	EGB3035FFG	—	EGE3035FFG	—	EGH3035FFG	—	EGC3035FFG		
40	EG	EGB3040FFG	—	EGE3040FFG	—	EGH3040FFG	—	EGC3040FFG		
45	EG	EGB3045FFG	—	EGE3045FFG	—	EGH3045FFG	—	EGC3045FFG		
50	EG	EGB3050FFG	—	EGE3050FFG	—	EGH3050FFG	—	EGC3050FFG		
60	EG	EGB3060FFG	—	EGE3060FFG	—	EGH3060FFG	—	EGC3060FFG		
70	EG	EGB3070FFG	—	EGE3070FFG	—	EGH3070FFG	—	EGC3070FFG		
80	EG	EGB3080FFG	—	EGE3080FFG	—	EGH3080FFG	—	EGC3080FFG		
90	EG	EGB3090FFG	—	EGE3090FFG	—	EGH3090FFG	—	EGC3090FFG		
100	EG	EGB3100FFG	—	EGE3100FFG	—	EGH3100FFG	—	EGC3100FFG		
110	EG	EGB3125FFG	—	EGE3125FFG	—	EGH3125FFG	—	EGC3125FFG		
125	EG	EGB3125FFG	—	EGE3125FFG	—	EGH3125FFG	—	EGC3125FFG	Base R9K3200FJ NEMA 4X handle PHB2N4XF 12" shaft SF320PH10X10 Fuse type Class J Terminal lugs #12-1	
150	JG	—	JGE3150FAG	—	JGS3150FAG	—	JGH3150FAG	JGC3150FAG		
175	JG	—	JGE3175FAG	—	JGS3175FAG	—	JGH3175FAG	JGC3175FAG		
200	JG	—	JGE3200FAG	—	JGS3200FAG	—	JGH3200FAG	JGC3200FAG		
225	JG	—	JGE3225FAG	—	JGS3225FAG	—	JGH3225FAG	JGC3225FAG		
250	JG	—	JGE3250FAG	—	JGS3250FAG	—	JGH3250FAG	JGC3250FAG		
300	LG	—	—	—	LGE3300FAG	—	LGH3300FAG	LGU3300FAG		
350	LG	—	—	—	LGE3350FAG	—	LGH3350FAG	LGU3350FAG		
400	LG	—	—	—	LGE3400FAG	—	LGH3400FAG	LGU3400FAG		
450	LG	—	—	—	LGE3500FAG	—	LGH3500FAG	LGU3500FAG		Base R9K3600FJ NEMA 4X handle PHB3N4XF 12" shaft SF320PH12X12 Fuse type Class J Terminal lugs 2x #2-2x 600 kcmil
500	LG	—	—	—	LGE3500FAG	—	LGH3500FAG	LGU3500FAG		
600	LG	—	—	—	LGE3600FAG	—	LGH3600FAG	LGU3600FAG		

Group motor design

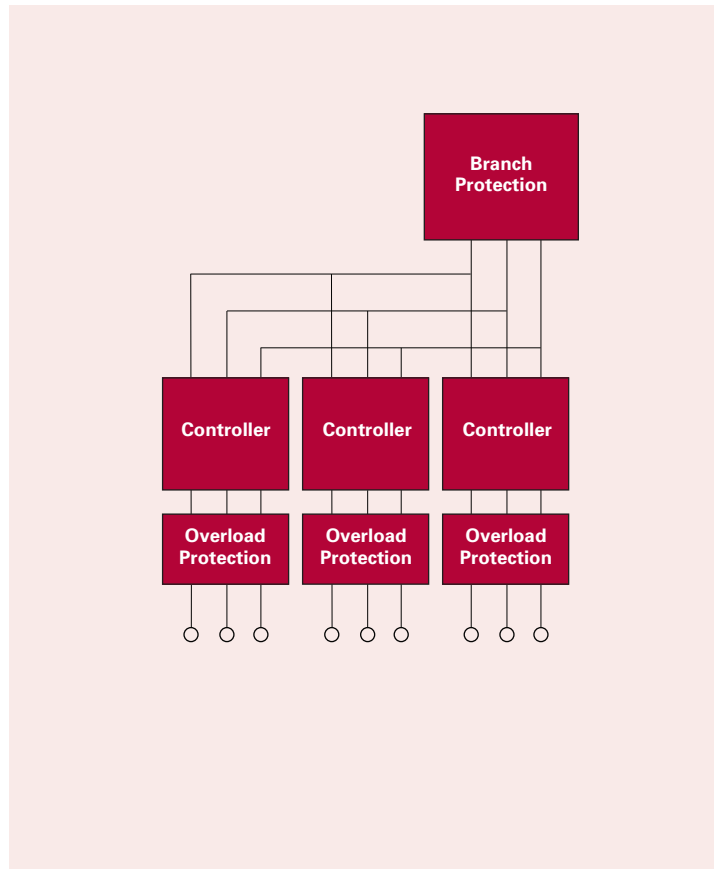

Group Motor—Multiple Motors Protected by a Single Set of Fuses or Breaker

The following rules apply to manual motor controllers for motor loads only:

A single set of fuses or breaker can be used if the following conditions are met:

1. All power circuit devices are rated for group motor use as indicated on the component, heater tables or instruction publication.
2. The following tap rule (31.4.3) is met:
 - a. The conductors to the individual loads are not less than 1/10 the ampacity of the branch circuit protection for each circuit provided with a manual motor controller (MMC) marked "Suitable as tap conductor protection in group installations." Also, the conductors on the load side of the MMC shall not have an ampacity less than 125% of the motor FLA.
3. The branch circuit protection is sized by the sum of the following:
 - a. If the branch protection is a breaker, 250% of the largest motor FLA, plus the sum of the remaining motor loads,
 - b. If the branch protection is a time delay fuse, 175% of the largest motor FLA, plus the sum of the remaining motor loads, or
 - c. If the branch protection is a CC fuse, 300% of the largest motor FLA, plus the sum of the remaining motor loads.
4. The branch circuit protection must not exceed the amp rating as specified in the group installation marking of the power circuit components and the type specified.



XT Manual Motor Controller (XTSC)



Note: UL 508 Type F combination motor controllers (XTFC) are self-protected and do not limit the upstream protective devices.

Manual Motor Controllers Short-Circuit Ratings for UL/CSA® Group Installations

XTSC and XTSR Manual Motor Controllers (MMC) / Starter Combinations

Assembled Controller			Group Installation, UL/CSA				
			Maximum rms Symmetrical Short-Circuit Ratings (kA)			Maximum Upstream Protective Device (Amps)	
Non-Reversing	Reversing	FLA Adjustment Range/Overload Release – I _r (Amps)	240V	480V	600V	Maximum Fuse 600V	Maximum Circuit Breaker 600V
XTSC and XTSR Frame B MMP + Frame B Contactor							
XTSCP16BBA	XTSRP16BBA	0.1–0.16	50	50	50	600	600
XTSCP25BBA	XTSRP16BBA	0.16–0.25	50	50	50	600	600
XTSCP40BBA	XTSRP40BBA	0.25–0.4	50	50	50	600	600
XTSCP63BBA	XTSRP63BBA	0.4–0.63	50	50	50	600	600
XTSC001BBA	XTSR001BBA	0.63–1	50	50	50	600	600
XTSC1P6BBA	XTSR1P6BBA	1–1.6	50	50	50	600	600
XTSCAP5BBA	XTSR2P5BBA	1.6–2.5	50	50	50	600	600
XTSC004BBA	XTSR004BBA	2.5–4	50	50	50	600	600
XTSC6P3BBA	XTSR6P3BBA	4–6.3	50	50	50	600	600
XTSC010BBA	XTSR010BBA	6.3–10	22	22	22	150	125
XTSC012BBA	XTSR012BBA	8–12	10	10	10	150	125
XTSC016BBA	—	10–16	10	10	10	150	125
XTSC and XTSR Frame B MMP + Frame C Contactor							
XTSC016BCA	XTSR016BCA	10–16	10	10	10	150	125
XTSC020BCA	XTSR020BCA	16–20	10	10	10	150	125
XTSC025BCA	XTSR025BCA	20–25	10	10	10	150	125
XTSC032BCA	XTSR032BCA	25–32	5	5	5	150	125
XTSC and XTSR Frame D MMP + Frame C Contactor							
XTSC016DCA	XTSR016DCA	10–16	50	50	10	600	600
XTSC025DCA	XTSR025DCA	16–25	50	50	10	600	600
XTSC032DCA	XTSR032DCA	25–32	50	50	10	600	600
XTSC and XTSR Frame D MMP + Frame D Contactor							
XTSC040DDA	XTSR040DDA	32–40	50	50	10	600	600
XTSC050DDA	XTSR050DDA	40–50	50	50	10	600	600
XTSC058DDA	XTSR058DDA	50–58	50	50	—	—	—
XTSC063DDA	XTSR063DDA	55–63	50	50	—	—	—

Note: Products are shown with a 120 Vac coil. For other coil voltages, replace the "A" suffix with the corresponding letter from the following table.

Coil Voltage	Suffix
120 Vac	A
24 Vdc	TD
24 Vac	T
240 Vac	B

Refer to Page 5 for breaker part numbers and to Page 19 for fuse base part numbers.



Individual circuit for motor load

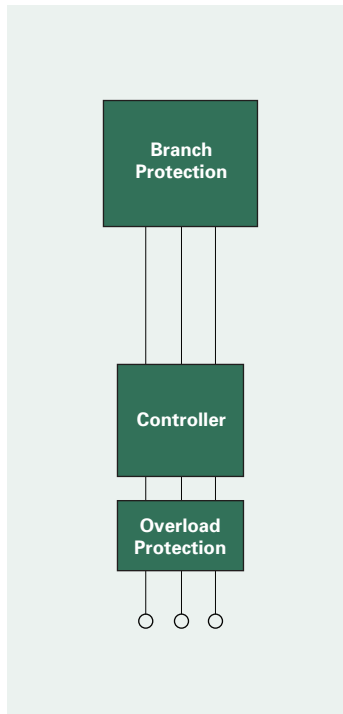

Individual Circuit for Motor Load

There are several ways to build a branch circuit for a motor load. Each method provides short-circuit protection, motor overload protection, and the ability to start and stop the motor. Some additionally provide a means to disconnect the branch circuit for maintenance and safety purposes.

UL 508 Type F Combination Motor Controllers (CMCs) (manual motor protector + contactor + line-side adapter) provide the most efficient means to build a branch circuit for a motor. CMCs are designed for motor loads such that they do not need to be oversized (as breakers and fuses are) to prevent tripping during motor startup. CMCs not only take up less space, but also install more quickly.

For selection of motor branch circuits for 240V, refer to Pages 10 and 11.

For selection of motor branch circuits for 480V, refer to Pages 12 and 13.



Motor Branch Circuit Types
Motor Branch Devices

Fuse and Starter



Fuses
Short-circuit protection

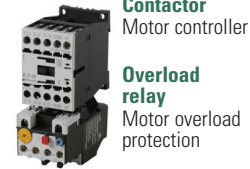

Contactor
Motor controller
Overload relay
Motor overload protection

Breaker and Starter

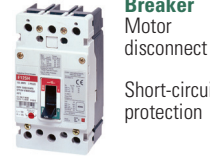

Breaker
Motor disconnect
Short-circuit protection

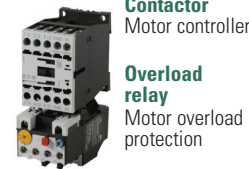

Contactor
Motor controller
Overload relay
Motor overload protection

Motor Circuit Protector and Starter

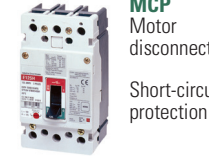

MCP
Motor disconnect
Short-circuit protection

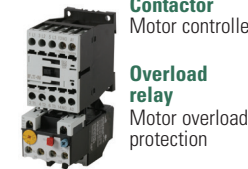

Contactor
Motor controller
Overload relay
Motor overload protection

Combination Motor Controller (Type F)



CMC
Motor disconnect
Short-circuit and motor overload protection
Motor controller

Branch circuit functions

Disconnect function	Disconnect (separate)	Breaker	Motor circuit protector	Manual motor protector
Short-circuit protection	Fuse block/fuses	Breaker	Motor circuit protector	Manual motor protector
Motor controller	Contactor	Contactor	Contactor	Contactor
Motor overload protection	Overload relay	Overload relay	Overload relay	Manual motor protector

Installation

Installation effort	High	Moderate	Moderate	Low
Line-side commoning links	Not available	Not available	Not available	Yes

Usability

Controller options	Remote	Remote	Remote	Manual or remote
Resetability after short circuit	Replacement fuses necessary	Reset breaker switch	Reset MCP switch	Reset CMC switch

Protection

Sizing protective devices	Fuses are sized up to 300% of the FLA to prevent nuisance tripping during startup. Because the fuses are oversized for the motor FLA, an overload relay is also needed.	Breakers are sized up to 250% of the FLA to prevent nuisance tripping during startup. Because the breaker is oversized for the motor FLA, an overload relay is also needed.	MCPs are sized up to 800 to 1100% of the FLA to prevent nuisance tripping during startup. Because the MCP provides no thermal protection, an overload relay is needed.	CMCs are sized according to the motor FLA to provide overload protection. The CMC includes short circuit that is designed to mimic the motor inrush (14 times FLA).
---------------------------	---	---	--	---

Safety

Padlockable provision	No, unless provided in a separate disconnect	Yes, with breaker accessory	Yes, with MCP accessory	Included in MMP
-----------------------	--	-----------------------------	-------------------------	-----------------

Cost

Component price	Low	Moderate	Moderate	Low
Panel space (and cost)	Moderate	Moderate	Moderate	Low

Components used to build a reversing contactor

For reversing applications, the contactors should have mechanical and electrical interlocks. For Frame B, use contactors with a built-in NC auxiliary (ending in "B01A" instead of "B10A").

Quantity	Frame	B	C	D	F	G
2	Contactors	XTCE...B01	XTCE...C01	XTCE...D00	XTCE...F00	XTCE...G00
2	Auxiliary contact (front)	XTCEXFAC20	XTCEXFAC20	XTCEXFBG11	XTCEXFBG11	XTCEXFBG11
1	Mechanical interlock	XTCEXMLB	XTCEXMLC	XTCEXMLD	XTCEXMLG	XTCEXMLG
1	Reversing link kit	XTCEXRLB	XTCEXRLC	XTCEXRLD	XTCEXRLG	XTCEXRLG

Branch Motor Selection for 230 Vac

	HP (230V)	1/2	3/4	1	1-1/2	2	3	5	7-1/2
FLA	2.2	3.2	4.2	6	6.8	9.6	15.2	22	
Minimum Wire Size (AWG)	14	14	14	14	14	14	14	12	10
Fuse amperage	3	6	10	15	15	15	30	40	
Fuse type	CC	CC	CC	CC	CC	CC	J	J	
Contactor	XTCE007B10A	XTCE007B10A	XTCE007B10A	XTCE007B10A	XTCE007B10A	XTCE009B10A	XTCE015B10A	XTCE025C10A	
Auxiliary contact	1NO aux built-in	1NO aux built-in	1NO aux built-in	1NO aux built-in	1NO aux built-in	1NO aux built-in	1NO aux built-in	1NO aux built-in	1NO aux built-in
Thermal overload relay	XTOB2P4BC1	XTOB004BC1	XTOB006BC1	XTOB010BC1	XTOB010BC1	XTOB010BC1	XTOB016BC1	XTOB024CC1	
Overload range (A)	1.6 to 2.4	2.4 to 4.0	4 to 6	6 to 10	6 to 10	6 to 10	12 to 16	16 to 24	
SCCR (kA)	100	100	100	100	100	100	100	100	
Breaker	EGH015FFG	EGH015FFG	EGH015FFG	EGH015FFG	EGH015FFG	EGH020FFG	EGH030FFG	EGH040FFG	
Breaker size (A)	15	15	15	15	15	20	30	40	
Contactor	XTCE007B10A	XTCE007B10A	XTCE007B10A	XTCE007B10A	XTCE007B10A	XTCE009B10A	XTCE015B10A	XTCE025C10A	
Auxiliary contact	1NO aux built-in	1NO aux built-in	1NO aux built-in	1NO aux built-in	1NO aux built-in	1NO aux built-in	1NO aux built-in	1NO aux built-in	1NO aux built-in
Thermal overload relay	XTOB2P4BC1	XTOB004BC1	XTOB006BC1	XTOB010BC1	XTOB010BC1	XTOB010BC1	XTOB016BC1	XTOB024CC1	
Overload range (A)	1.6 to 2.4	2.4 to 4.0	4 to 6	6 to 10	6 to 10	6 to 10	12 to 16	16 to 24	
SCCR (kA)	—	—	—	—	—	—	—	50 kA ¹	
Motor circuit protector	HMCP003A0C	HMCP007C0C	HMCP007C0C	HMCP007C0C	HMCP007C0C	HMCP007C0C	HMCP007C0C	HMCP007C0C	HMCP007C0C
Contactor	XTCE007B10A	XTCE007B10A	XTCE007B10A	XTCE007B10A	XTCE007B10A	XTCE009B10A	XTCE015B10A	XTCE025C10A	
Auxiliary contact	1NO aux built-in	1NO aux built-in	1NO aux built-in	1NO aux built-in	1NO aux built-in	1NO aux built-in	1NO aux built-in	1NO aux built-in	1NO aux built-in
Thermal overload relay	XTOB2P4BC1	XTOB004BC1	XTOB006BC1	XTOB010BC1	XTOB010BC1	XTOB010BC1	XTOB016BC1	XTOB024CC1	
Overload range	1.6 to 2.4	2.4 to 4.0	4 to 6	6 to 10	6 to 10	6 to 10	12 to 16	16 to 24	
SCCR (kA)	35	35	15	65	65	65	65	65	
Combination motor controller	XTFC2P5BBA	XTFC004BBA	XTFC6P3BBA	XTFC6P3BBA	XTFC6P3BBA	XTFC010BBA	XTFC010BBA	XTFC016BBA	XTFC025BCA
Overload range (A)	1.6 to 2.5	2.5 to 4.0	4 to 6.3	4 to 6.3	6.3 to 10	6.3 to 10	10 to 16	20 to 25	
SCCR (kA)	65	65	65	65	65	65	50	18	

¹ UL Pending.

Branch Motor Selection for 230 Vac, continued

	HP (230V)	10	15	20	25	30	40	50	60
FLA	28	42	54	68	80	104	130	154	
Minimum Wire Size (AWG)	8	6	4	4	3	1	2/0	3/0	
Fuse amperage	50	80	100	125	150	200	225	300	
Fuse type	J	J	J	J	J	J	J	J	J
Contactor	XTCE032C10A	XTCE050D00A	XTCE065D00A	XTCE065D00A	XTCE080F00A	XTCE150G00A	XTCE150G00A	XTCE150G00A	XTCE150G00A
Auxiliary contact	1NO aux built-in	1NO/1NC side aux XTCEXSBN11	1NO/1NC side aux XTCEXSBN11	1NO/1NC side aux XTCEXSBN11	1NO/1NC side aux XTCEXSBN11	1NO/1NC side aux XTCEXSBN11	1NO/1NC side aux XTCEXSBN11	1NO/1NC side aux XTCEXSBN11	1NO/1NC side aux XTCEXSBN11
Thermal overload relay	XTOB032CC1	XTOB057DC1	XTOB065DC1	XTOB075DC1	XTOB100GC1	XTOB125GC1	XTOB150GC1	XTOB175GC1	
Overload range (A)	24 to 32	40 to 57	50 to 65	65 to 75	70 to 100	95 to 125	120 to 150	145 to 175	
SCCR (kA)	100	100	100	—	100	100	100	100	
Breaker	EGH050FFG	EGH080FFG	EGH100FFG	EGH125FFG	JGE150FAG	JGE200FAG	JGE250FAG	LGE3300FAG	
Breaker size (A)	50	80	100	125	150	200	250	—	
Contactor	XTCE025C10A	XTCE040D00A	XTCE050D00A	XTCE065D00A	XTCE080F00A	XTCE095F00A	XTCE115G00A	XTCE150G00A	
Auxiliary contact	1NO aux built-in	1NO/1NC side aux XTCEXSBN11	1NO/1NC side aux XTCEXSBN11	1NO/1NC side aux XTCEXSBN11	1NO/1NC side aux XTCEXSBN11	1NO/1NC side aux XTCEXSBN11	1NO/1NC side aux XTCEXSBN11	1NO/1NC side aux XTCEXSBN11	1NO/1NC side aux XTCEXSBN11
Thermal overload relay	XTOB032CC1	XTOB057DC1	XTOB065DC1	XTOB075DC1	XTOB100GC1	XTOB125GC1	XTOB150GC1	XTOB175GC1	
Overload range (A)	24 to 32	40 to 57	50 to 65	65 to 75	70 to 100	95 to 125	120 to 150	145 to 175	
SCCR (kA)	50 kA ①	50 kA ①	50 kA ①	50 kA ①	65 kA ①	65 kA ①	65 kA ①	42 kA ①	
Motor circuit protector	HMCPPE050K2C	HMCPPE100R3C	HMCPPE100T3C	—	—	—	—	—	
Contactor	XTCE032C10A	XTCE040D00A	XTCE050D00A						
Auxiliary contact	1NO aux built-in	1NO/1NC side aux XTCEXSBN11	1NO/1NC side aux XTCEXSBN11	1NO/1NC side aux XTCEXSBN11	1NO/1NC side aux XTCEXSBN11	1NO/1NC side aux XTCEXSBN11	1NO/1NC side aux XTCEXSBN11	1NO/1NC side aux XTCEXSBN11	1NO/1NC side aux XTCEXSBN11
Thermal overload relay	XTOB032CC1	XTOB057DC1	XTOB057DC1	—	—	—	—	—	
Overload range (A)	24 to 32	40 to 57	40 to 57	—	—	—	—	—	
SCCR (kA)	65	65	65	—	—	—	—	—	
Combination motor controller or MPCB + contactor	XTFC032BCA	XTFC050DDA	XTFC058DDA	FDMP 3080L + XTCE080F00A	FDMP 3100L + XTCE080F00A	FDMP 3160L + XTCE085F00A	FDMP 3160L + XTCE115G00A	FDMP 3160L + XTCE150G00A	
Overload range (A)	25 to 32	40 to 50	50 to 58	40 to 80	80 to 100	100 to 160	100 to 160	100 to 160	
SCCR (kA)	18	65	65	65	65	65	65	65	

① UL Pending.

Note: Contactors are shown with a 120 Vac coil. For other coil voltages, replace the "A" suffix with the corresponding letter from the following table.

Coil Voltage	Suffix
120 Vac	A
24 Vdc	TD
24 Vac	T
240 Vac	B

Branch Motor Selection for 460 Vac

	HP (480V)	1/2	3/4	1	1-1/2	2	3	5	7-1/2
FLA	1.1	1.6	2.1	3.0	3.4	4.8	7.6	11	
Minimum Wire Size (AWG)	14	14	14	14	14	14	14	14	14
Fuse amperage	3	3	3	6	6	10	15	30	
Fuse type	CC	CC	CC	CC	CC	CC	CC	CC	CC
Contactor	XTCE007B10A	XTCE007B10A	XTCE007B10A	XTCE007B10A	XTCE007B10A	XTCE007B10A	XTCE007B10A	XTCE009B10A	XTCE012B10A
Auxiliary contact	1NO aux built-in	1NO aux built-in	1NO aux built-in	1NO aux built-in	1NO aux built-in	1NO aux built-in	1NO aux built-in	1NO aux built-in	1NO aux built-in
Thermal overload relay	XTOB1P6BC1	XTOB2P4BC1	XTOB2P4BC1	XTOB004BC1	XTOB004BC1	XTOB006BC1	XTOB010BC1	XTOB012BC1	
Overload range (A)	1.0 to 1.6	1.6 to 2.4	1.6 to 2.4	2.4 to 4	2.4 to 4	4 to 6	6 to 10	9 to 12	
High fault rating (kA)	100	100	100	100	100	100	100	100	100
Breaker	EGE3015FFG	EGE3015FFG	EGE3015FFG	EGE3015FFG	EGE3015FFG	EGE3015FFG	EGE3015FFG	EGE3015FFG	EGE3025FFG
Breaker size (A)	15A EG frame	15A EG frame	15A EG frame	15A EG frame	15A EG frame	15A EG frame	15A EG frame	15A EG frame	25A EG frame
Contactor	XTCE007B10A	XTCE007B10A	XTCE007B10A	XTCE007B10A	XTCE007B10A	XTCE007B10A	XTCE007B10A	XTCE009B10A	XTCE012B10A
Auxiliary contact	1NO aux built-in	1NO aux built-in	1NO aux built-in	1NO aux built-in	1NO aux built-in	1NO aux built-in	1NO aux built-in	1NO aux built-in	1NO aux built-in
Thermal overload relay	XTOB1P6BC1	XTOB2P4BC1	XTOB2P4BC1	XTOB004BC1	XTOB004BC1	XTOB006BC1	XTOB010BC1	XTOB012BC1	
Overload range (A)	1.0 to 1.6	1.6 to 2.4	1.6 to 2.4	2.4 to 4	2.4 to 4	4 to 6	6 to 10	9 to 12	
High fault rating	—	—	—	—	—	—	—	—	—
Motor circuit protector	HMCP003A0C	HMCP003A0C	HMCP003A0C	HMCP003A0C	HMCP003A0C	HMCP003A0C	HMCPE015E0C	HMCPE015E0C	HMCPE015E0C
Contactor	XTCE007B10A	XTCE007B10A	XTCE007B10A	XTCE007B10A	XTCE007B10A	XTCE007B10A	XTCE007B10A	XTCE009B10A	XTCE012B10A
Auxiliary contact	1NO aux built-in	1NO aux built-in	1NO aux built-in	1NO aux built-in	1NO aux built-in	1NO aux built-in	1NO aux built-in	1NO aux built-in	1NO aux built-in
Thermal overload relay	XTOB1P6BC1	XTOB2P4BC1	XTOB2P4BC1	XTOB004BC1	XTOB004BC1	XTOB006BC1	XTOB010BC1	XTOB012BC1	
Overload range (A)	1.0 to 1.6	1.6 to 2.4	1.6 to 2.4	2.4 to 4	2.4 to 4	4 to 6	6 to 10	9 to 12	
High fault rating (kA)	35	35	35	35	35	65	65	65	
Combination motor controller	XTFC1P6BBA	XTFC2P5BBA	XTFC2P5BBA	XTFC004BBA	XTFC004BBA	XTFC6P3BBA	XTFC010BBA	XTFC012BBA	
Overload range (A)	1.0 to 1.6	1.6 to 2.5	1.6 to 2.5	2.5 to 4.0	2.5 to 4.0	4 to 6.3	6 to 10	8 to 12	
SCCR (kA) (480/277V)	65	65	65	65	65	65	65	65	65



Fuse Starter



Breaker Starter



MCP- Starter



CMC

Branch Motor Selection for 460 Vac, continued

	10	15	20	25	30	40	50	60
HP (480V)	10	15	20	25	30	40	50	60
FLA	14	21	27	34	40	52	65	77
Minimum Wire Size (AWG)	12	10	8	8	8	6	4	3
Fuse amperage	25	35	50	60	70	90	125	150
Fuse type	J	J	J	J	J	J	J	J
Contactor	XTCE015B10A	XTCE025C10A	XTCE032C10A	XTCE040D00A	XTCE040D00A	XTCE050D00A	XTCE065D00A	XTE080F00A
Auxiliary contact	1NO aux built-in	1NO aux built-in	1NO aux built-in	1NO-1NC side aux XTCEXSBN11	1NO-1NC side aux XTCEXSBN11	1NO-1NC side aux XTCEXSBN11	1NO-1NC side aux XTCEXSBN11	1NO-1NC side aux XTCEXSBN11
Thermal overload relay	XTOB016BC1	XTOB024CC1	XTOB032CC1	XTOB040DC1	XTOB057DC1	XTOB057DC1	XTOB065DC1	XTOB100GC1
Overload range (A)	12 to 16	16 to 24	24 to 32	24 to 40	40 to 57	40 to 57	50 to 65	70 to 100
High fault rating (kA)	100	100	100	100	100	100	100	100
Breaker	EGH3035FFG	EGH3040FFG	EGH3050FFG	EGH3070FFG	EGH3080FFG	EGH3100FFG	EGH3125FFG	JGH3150FAG
Breaker size (A)	35A EG frame	40A EG frame	50A EG frame	70A EG frame	80A EG frame	100A EG frame	125A EG frame	150A JG frame
Contactor	XTCE015B10A	XTCE025C10A	XTCE032C10A	XTCE040D00A	XTCE040D00A	XTCE050D00A	XTCE065D00A	XTE080F00A
Auxiliary contact	1NO aux built-in	1NO aux built-in	1NO aux built-in	1NO-1NC side aux XTCEXSBN11	1NO-1NC side aux XTCEXSBN11	1NO-1NC side aux XTCEXSBN11	1NO-1NC side aux XTCEXSBN11	1NO-1NC side aux XTCEXSBN11
Thermal overload relay	XTOB016BC1	XTOB024CC1	XTOB032CC1	XTOB040DC1	XTOB057DC1	XTOB057DC1	XTOB075DC1	XTOB100GC1
Overload range (A)	12 to 16	16 to 24	24 to 32	24 to 40	40 to 57	40 to 57	65 to 75	70 to 100
High fault rating	—	65 kA ①	65 kA ①	65 kA ①	65 kA ①	65 kA ①	65 kA ①	65 kA ①
Motor circuit protector	HMCPE030H1C	HMCPE030H1C	HMCPE050K2C	HMCPE050K2C	HMCPE100R3C	HMCPE100R3C	HMCPE100R3C	HMCPE100T3C
Contactor	XTCE015B10A	XTCE025C10A	XTCE032C10A	XTCE040D00A	XTCE040D00A	XTCE050D00A	XTCE065D00A	XTE080F00A
Auxiliary contact	1NO aux built-in	1NO aux built-in	1NO aux built-in	1NO-1NC side aux XTCEXSBN11	1NO-1NC side aux XTCEXSBN11	1NO-1NC side aux XTCEXSBN11	1NO-1NC side aux XTCEXSBN11	1NO-1NC side aux XTCEXSBN11
Thermal overload relay	XTOB016BC1	XTOB024CC1	XTOB032CC1	XTOB040DC1	XTOB057DC1	XTOB057DC1	XTOB065DC1	XTOB100GC1
Overload range (A)	12 to 16	16 to 24	24 to 32	24 to 40	40 to 57	40 to 57	50 to 65	70 to 100
High fault rating (kA)	65	65	65	65	65	65	65	65
Combination motor controller or MPCB + contactor	XTFC016BBA	XTFC025BCA	XTFC032BCA	XTFC040DDA	XTFC050DDA	XTFC058DDA	XTFC063DDA	FDMP 3080L + XTCE080F00A
Overload range (A)	10 to 16	20 to 25	25 to 32	32 to 40	40 to 50	50 to 58	55 to 65	40 to 80
SCCR (kA) (480/277V)	50	18	18	65	65	65	65	65

① UL Pending.

Note: Contactors are shown with a 120 Vac coil. For other coil voltages, replace the "A" suffix with the corresponding letter from the following table.

Coil Voltage	Suffix
120 Vac	A
24 Vdc	TD
24 Vac	T
240 Vac	B



Heater and lighting load circuits

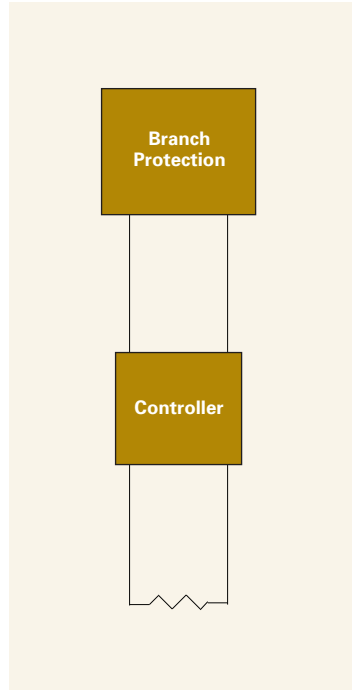

Heater or Lighting Load

Heater loads:

The branch circuit protection is sized (see Section 31.6.1 exceptions for larger heater loads):

1. Not less than 125% of the heater load,
2. Not more than 60A, and
3. Not larger than the ampacity of the field wiring to the heater load.

Controllers are sized to the heater full-load rating using the controller's general-purpose amp rating or resistive load rating.

Lighting loads:

The branch circuit protection for standard-duty incandescent lampholders or fluorescent ballasts (see Section 31.8.2 for larger lighting loads):

1. Shall not exceed 15A, and
2. Shall not exceed the ampacity of the anticipated field wiring

The controllers are sized to the specific lighting ratings.



Contactors



Definite Purpose Contactor

Resistive Load (A)	Definite Purpose Contactor	
	Two-Pole	Three-Pole
20	C25DRF215A	C25DRF315A
35	C25DRF225A	C25DRF325A
40	C25DRF230A	C25DRF330A
50	C25DRF240A	C25DRF340A
65	C25DRJ250A	C25DRJ350A



Electrically Held Lighting Contactor

Ballast or Mercury Vapor Load (at 600V)	Tungsten Load (at 480V)	Electrically Held Lighting Contactor		
		2NO	3NO	4NO
10	10	CN35AN2AB	CN35AN3AB	CN35AN4AB
20	20	CN35BN2AB	CN35BN3AB	CN35BN4AB



IEC Contactor

General Purpose Amps	IEC Contactor	
	Three-Pole	Four-Pole
20	XTCE015B10A	XTCF020B00A
40	XTCE032C10A	XTCF045C10A
63	XTCE040D00A	XTCF063D00A



Heater application between...			Single-Pole	Two-Pole	Two-Pole	Three-Pole	Molded Case Circuit Breaker			
Breaker Rating (A)	Minimum	Maximum	Miniature Breaker	Miniature Breaker	Molded Case Circuit Breaker	Miniature Breaker	Molded Case Circuit Breaker			
			10 kA 277V 10 kA 120V	10 kA 480V 10 kA 240V	18 kA 480V 25 kA 240V	65 kA 480V 50 kA 240V	10 kA 480V 10 kA 240V	18 kA 480V 25 kA 240V	35 kA 480V 43 kA 240V	65 kA 480V 50 kA 240V
0.5	-	0.4	WMZT1CX0	WMZT2CX0	EGB2015FFG	EGH2015FFG	WMZT3CX0	EGB3015FFG	EGE3015FFG	EGH3015FFG
1	0.4	0.8	WMZT1C01	WMZT2C01	—	—	WMZT3C01	—	—	—
1.5	0.8	1.2	WMZT1CX1	WMZT2CX1	—	—	WMZT3CX1	—	—	—
2	1.2	1.6	WMZT1C02	WMZT2C02	—	—	WMZT3C02	—	—	—
3	1.6	2.4	WMZT1C03	WMZT2C03	—	—	WMZT3C03	—	—	—
4	2.4	3.2	WMZT1C04	WMZT2C04	—	—	WMZT3C04	—	—	—
5	3.2	4	WMZT1C05	WMZT2C05	—	—	WMZT3C05	—	—	—
6	4.0	4.8	WMZT1C06	WMZT2C06	—	—	WMZT3C06	—	—	—
7	4.8	5.6	WMZT1C07	WMZT2C07	—	—	WMZT3C07	—	—	—
8	5.6	6.4	WMZT1C08	WMZT2C08	—	—	WMZT3C08	—	—	—
10	6.4	8	WMZT1C10	WMZT2C10	—	—	WMZT3C10	—	—	—
13	8.0	10.4	WMZT1C13	WMZT2C13	—	—	WMZT3C13	—	—	—
15	10.4	12	WMZT1C15	WMZT2C15	—	—	WMZT3C15	—	—	—
20	12.0	16	WMZT1C20	WMZT2C20	EGB2020FFG	EGH2020FFG	WMZT3C20	EGB3020FFG	EGE3020FFG	EGH3020FFG
25	16.0	20	WMZT1C25	WMZT2C25	EGB2025FFG	EGH2025FFG	WMZT3C25	EGB3025FFG	EGE3025FFG	EGH3025FFG
30	20.0	24	WMZT1C30	WMZT2C30	EGB2020FFG	EGH2020FFG	WMZT3C30	EGB3030FFG	EGE3030FFG	EGH3030FFG
35	24.0	28	WMZT1C35	WMZT2C35	EGB2035FFG	EGH2035FFG	WMZT3C35	EGB3035FFG	EGE3035FFG	EGH3035FFG
40	28.0	32	WMZT1C40	WMZT2C40	EGB2040FFG	EGH2040FFG	WMZT3C40	EGB3040FFG	EGE3040FFG	EGH3040FFG
45	32.0	36	—	—	EGB2045FFG	EGH2045FFG	—	EGB3045FFG	EGE3045FFG	EGH3045FFG
50	36.0	40	—	—	EGB2050FFG	EGH2050FFG	—	EGB3050FFG	EGE3050FFG	EGH3050FFG
60	40.0	48	—	—	EGB2060FFG	EGH2060FFG	—	EGB3060FFG	EGE3060FFG	EGH3060FFG

Power circuit wiring

This section refers to the wiring in the feeder and branch circuits. For information on wiring in the control circuit, see Page 26.

Internal wiring (Reference Section 29, 66.5):

- All internal wiring conductors shall be copper.
- All conductors in the power circuit should be labeled at the termination point with letters or numbers corresponding with the wiring diagram provided in the industrial control panel.
- Power circuit conductors should not be smaller than 14 AWG.
- For single loads, power circuit conductors for motors or heater loads should be sized for an ampacity not less than 125% of the full-load current.
- For multiple loads, such as multiple motors or a motor with other loads, power circuit conductors shall be sized for an ampacity not less than 125% of all heater loads plus 125% of the largest motor load plus the full-load ampere ratings of all remaining motors and other loads that are simultaneously operable.
- The wire size is selected from the table on Page 17 based on the calculated wire ampacity. Conductors used in group motor applications should also comply with Table 66.2 (Reference Section 66.7.5).

Field wiring (Reference Section 28.3, 66.4):

- Not smaller than 14 AWG.
- For single loads, the field wiring conductors should be sized for an ampacity of 125% of the full-load current.
- For multiple loads, such as multiple motors or a motor with other loads, the field wiring is sized based on the sum of 125% of the largest motor FLA, plus the sum of the other full-load currents of the remaining loads.
- The wire size is selected from the table on Page 17 based on the calculated wire ampacity.

Wire color designation (internal power circuit wiring)



Black:

All ungrounded power circuit conductors regardless of voltage



White or gray or three continuous white stripes on other than green, blue, orange or yellow:

Grounded AC current-carrying power circuit conductor regardless of voltage



Exception: Insulated conductors sized 4 AWG (21.2 mm²) or larger and having insulation colored other than as in Section 17.4 shall be identified at each termination point by a white marking, such as tape wrapped around the conductor.

To determine the wire size for motor loads, add the full-load current ratings found in Table 50.1 for all external loads being carried by the conductor. Then use Table 28.1 on the following page to determine the wire size for the calculated ampacity.

Full-Load Motor-running Currents in Amperes Corresponding to Various AC Horsepower Ratings—Reference Table 50.1

HP	110–120V		200V		208V		220–240V ①		380–415V		440–480V		550–600V	
	Single-Phase	Three-Phase	Single-Phase	Three-Phase	Single-Phase	Three-Phase	Single-Phase	Three-Phase	Single-Phase	Three-Phase	Single-Phase	Three-Phase	Single-Phase	Three-Phase
1/10	3.0	—	—	—	—	—	1.5	—	1.0	—	—	—	—	—
1/8	3.8	—	—	—	—	—	1.9	—	1.2	—	—	—	—	—
1/6	4.4	2.5	—	2.4	—	—	2.2	—	1.4	—	—	—	—	—
1/4	5.8	3.3	—	3.2	—	—	2.9	—	1.8	—	—	—	—	—
1/3	7.2	4.1	—	4.0	—	—	3.6	—	2.3	—	—	—	—	—
1/2	9.8	5.6	2.5	5.4	2.4	—	4.9	2.2	3.2	1.3	2.5	1.1	2.0	0.9
3/4	13.8	7.9	3.7	7.6	3.5	—	6.9	3.2	4.5	1.8	3.5	1.6	2.8	1.3
1	16.0	9.2	4.8	8.8	4.6	—	8.0	4.2	5.1	2.3	4.0	2.1	3.2	1.7
1 1/2	20.0	11.5	6.9	11.0	6.6	—	10.0	6.0	6.4	3.3	5.0	3.0	4.0	2.4
2	24.0	13.8	7.8	13.2	7.5	—	12.0	6.8	7.7	4.3	6.0	3.4	4.8	2.7
3	34.0	19.6	11.0	18.7	10.6	—	17.0	9.6	10.9	6.1	8.5	4.8	6.8	3.9
5	56.0	32.2	17.5	30.8	16.7	—	28.0	15.2	17.9	9.7	14.0	7.6	11.2	6.1
7 1/2	80.0	46.0	25.3	44.0	24.2	—	40.0	22.0	27.0	14.0	21.0	11.0	16.0	9.0
10	100.0	57.5	32.2	55.0	30.8	—	50.0	28.0	33.0	18.0	26.0	14.0	20.0	11.0
15	135.0	—	48.3	—	46.2	—	68.0	42.0	44.0	27.0	34.0	21.0	27.0	17.0
20	—	—	62.1	—	59.4	—	88.0	54.0	56.0	34.0	44.0	27.0	35.0	22.0
25	—	—	78.2	—	74.8	—	110.0	68.0	70.0	44.0	55.0	34.0	44.0	27.0
30	—	—	92.0	—	88.0	—	136.0	80.0	87.0	51.0	68.0	40.0	54.0	32.0
40	—	—	120.0	—	114.0	—	176.0	104.0	112.0	66.0	88.0	52.0	70.0	41.0
50	—	—	150.0	—	143.0	—	216.0	130.0	139.0	83.0	108.0	65.0	86.0	52.0
60	—	—	177.0	—	169.0	—	—	154.0	—	103.0	—	77.0	—	62.0
75	—	—	221.0	—	211.0	—	—	192.0	—	128.0	—	96.0	—	77.0
100	—	—	285.0	—	273.0	—	—	248.0	—	165.0	—	124.0	—	99.0
125	—	—	359.0	—	343.0	—	—	312.0	—	208.0	—	156.0	—	125.0
150	—	—	414.0	—	396.0	—	—	360.0	—	240.0	—	180.0	—	144.0
200	—	—	552.0	—	528.0	—	—	480.0	—	320.0	—	240.0	—	192.0
250	—	—	—	—	—	—	—	604.0	—	403.0	—	302.0	—	242.0
300	—	—	—	—	—	—	—	722.0	—	482.0	—	361.0	—	289.0
350	—	—	—	—	—	—	—	828.0	—	560.0	—	414.0	—	336.0
400	—	—	—	—	—	—	—	954.0	—	636.0	—	477.0	—	382.0
450	—	—	—	—	—	—	—	1030.0	—	—	—	515.0	—	412.0
500	—	—	—	—	—	—	—	1180.0	—	786.0	—	590.0	—	472.0

① To obtain full-load currents for 265 and 277 volt motors, decrease corresponding 220–240 volt ratings by 13 and 17 percent respectively.

For group motor applications where two or more motors are protected by a single device, wire sizes should comply with the fuse/breaker size in Table 66.2 at right.

Ampacities of Insulated Conductors—Reference Table 28.1

Wire Size		
AWG	mm ²	Copper 75°C (167°F)
14	2.1	15
12	3.3	20
10	5.3	30
8	8.4	50
6	13.3	65
4	21.2	85
3	26.7	100
2	33.6	115
1	42.4	130
1/0	53.5	150
2/0	67.4	175
3/0	85.0	200
4/0	107.2	230
250 kcmil	127	255
300	152	285
350	177	310
400	203	335
500	253	380
600	304	420
700	355	460
750	380	475
800	405	490
900	456	520
1000	506	545
1250	633	590
1500	760	625
1750	887	650
2000	1013	665

Note: For multiple conductors of the same size (1/0 AWG or larger) at a terminal, the ampacity is equal to the value in this table for that conductor multiplied by the number of conductors that the terminal is able to accommodate.

Relationship Between Conductor Size and Overcurrent Protection Rating for Power Circuits—Reference Table 66.2

Conductor Size		Maximum Rating of Non-Time Delay Fuse or Inverse Time Circuit Breaker (Amps)	Time Delay or Dual Element Fuse (Amps)
AWG	mm ²		
14	2.1	60	30
12	3.3	80	40
10	5.3	100	50
8	8.4	150	80
6	13.3	200	100
4	21.2	250	125
3	26.7	300	150
2	33.6	350	175
1	42.4	400	200
1/0	53.6	500	250
2/0	67.4	600	300
3/0	85.0	700	350
4/0	107.2	800	400

Accessories

Contactor Auxiliary Contacts

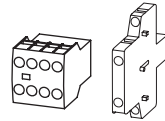

	Conventional Thermal Current, Open at 60°C $I_{th}=I_{br}$, AC-1 in Amps	Contact Configuration	Circuit Symbol	Package Quantity	Screw Terminals Catalog Number
Frame B-C Front (Top) Mount					
For use with XTCE... B XTCE... C	16	4NO		5	XTCEXFAC40
	16	3NO-1NC		5	XTCEXFAC31
	16	2NO-2NC		5	XTCEXFAC22
Frame C Side Mount					
For use with XTCE... C	10	1NO-1NC		1	XTCEXSCC11
Frame D-G					
For use with XTCE... D XTCE... F XTCE... G	16	4NO-0NC		5	XTCEXFBG40
	16	3NO-1NC		5	XTCEXFBG31
	16	2NO-2NC		5	XTCEXFBG22
Frame D-R					
For use with XTCE... D XTCE... F XTCE... G	10	1NO-1NC		1	XTCEXSBN11

EG Frame Multiwire Connectors Ordering Information

Maximum Amps	Wires per Terminal	Wire Size Range AWG Cu	Kit Catalog Number
125	3	14-2	3TA125E3K
125	6	14-6	3TA125E6K

JG Frame Multiwire Connectors Ordering Information

Maximum Amps	Wires per Terminal	Wire Size Range AWG Cu	Kit Catalog Number
250	3	14-2	3TA250FJ3
250	6	14-6	3TA250FJ6

Disconnect Fuse Holders Product Selection

Description	Standard Pack	Catalog Number
For Class CC Fuse		
Single-pole fuse holder	12	C383FHCC

MMP Accessories

Description	Catalog Number
Line-side adapter For use with XTPR... BC1	XTPAXLSA
Tool-less connector kit For use with XTPR... BC1 XTCE... B	XTPAXPCB
1NO-1NC Front mount auxiliary	XTPAXFA11
Commoning link For use with XTPR... BC1	XTPAXCLKA2
Commoning link For use with XTPR... BC1	XTPAXCLKA3
Commoning link For use with XTPR... BC1	XTPAXCLKA4
Commoning link For use with XTPR... BC1	XTPAXCLKA5
Handle mechanism	XTPAXRHMRY

Designing the control circuit

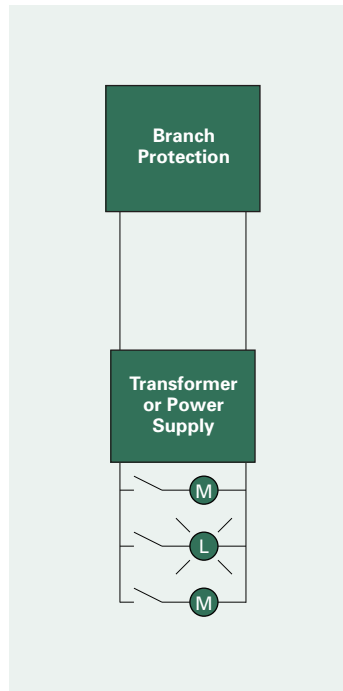

Control circuits provide the logic for the operation of the components in the power circuit. Control circuits are typically a lower, safer voltage, such as 120 Vac or 24 Vdc. Control power transformers (CPTs) and power supplies are used to transform or convert the power circuit voltage to the control circuit voltage.

Refer to Page 22 for selection of the CPT and protective devices.

Refer to Page 24 for selection of the power supply and protective devices.

Refer to Page 26 for control circuit wiring.

Eaton also offers a variety of control devices commonly used in control circuits.

Refer to Page 27 for pushbutton and pilot devices.

Refer to Page 28 for relays, timers, and terminal blocks.

Refer to Page 29 for programmable logic controllers and relays.

Common control circuit wiring

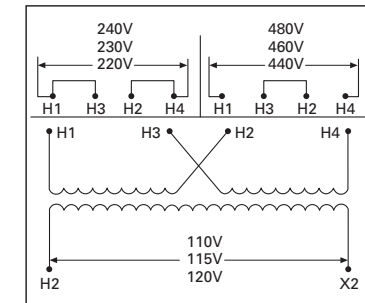
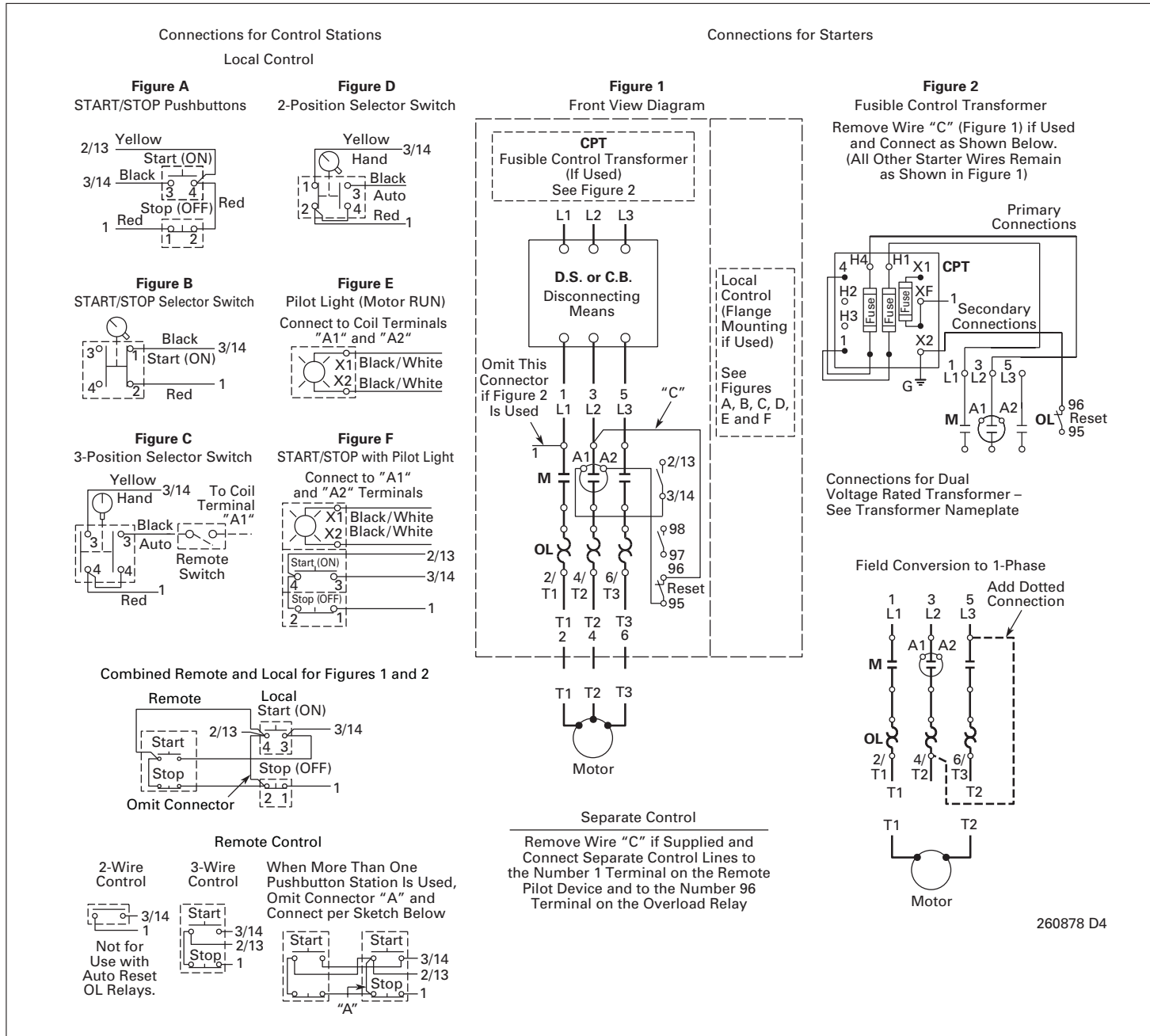

240V x 480V Primary, 120V Secondary CPT Wiring Diagram

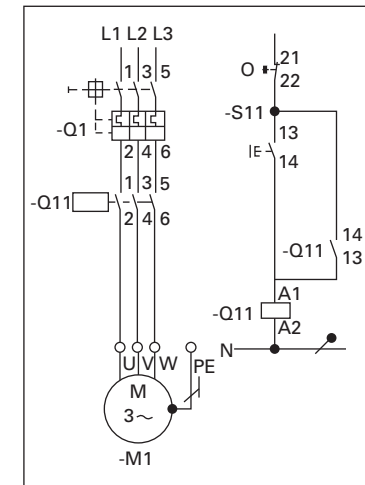

Manual Motor Controller and Combination Motor Controller Wiring Diagram

260878 D4

Sizing the control power transformer



- Use the following formula to determine the inrush power of the control power transformer (CPT) needed to support the components used in the application.

$$\text{CPT INRUSH VA} = \sqrt{(\text{INRUSH VA})^2 + (\text{SEALED VA})^2}$$

Example

Qty	Description	Inrush VA	Sealed VA	Total Inrush	Total Sealed
1	XTCE007B10A coil	25	3.3	25	3.3
2	XTCE018C10A coil	58	6.5	116	13.0
2	Relays	29	3.3	58	6.6
6	Indicating lights	7.0	7.0	42	42.0
	Total			241	65.0

$$\text{CPT INRUSH VA} = \sqrt{(241)^2 + (65)^2} = 250 \text{ VA}$$

- Select the CPT size based on the CPT inrush VA needed.

Selection Using Data from Previous Example

Part Number	Primary Voltage	Secondary Voltage	Transformer VA	Inrush VA (90% Sec. Inrush Voltage)
C0050E2A	240 x 480	120	50	200
→ C0075E2A	240 x 480	120	75	410
C0100E2A	240 x 480	120	100	540

C0075E2AFB has enough inrush VA capacity to handle the 250 VA inrush of the components.

CPT Selection Chart

CPT Part Number ①	Primary Voltage (AC)	Secondary Voltage (AC)	CPT VA	Inrush VA at 20% Power Factor	
				90% Secondary Voltage	95% Secondary Voltage
C0025E2A	240 x 480	120	25	130	100
C0050E2A	240 x 480	120	50	200	170
C0075E2A	240 x 480	120	75	410	310
C0100E2A	240 x 480	120	100	540	370
C0150E2A	240 x 480	120	150	930	780
C0200E2A	240 x 480	120	200	1150	810
C0250E2A	240 x 480	120	250	1900	1400
C0300E2A	240 x 480	120	300	2700	1900
C0350E2A	240 x 480	120	350	3650	3100
C0500E2A	240 x 480	120	500	5300	4000
C0750E2A	240 x 480	120	750	11000	8300
C1000E2A	240 x 480	120	1000	21000	15000

① Add "FB" to the end of the part number to include a double-pole primary fuse block for rejection type fuses. Not available for 25 VA.

Common Control Loads

Description	Part Number	Inrush VA	Sealed VA
7 to 15A XT Contactor Coil	XTCE...B...	25	3.3
18 to 32A XT Contactor Coil	XTCE...C...	58	6.5
40 to 72A XT Contactor Coil	XTCE...D...	154	14
80 to 95A XT Contactor Coil	XTCE...F...	372	37.1
115 to 170A XT Contactor Coil	XTCE...G...	170	3.1
Definite Purpose Contactor Coil	C25DRF...	75	5.8
Definite Purpose Contactor Coil	C25DRJ...	111	7.6
Lighting Contactor Coil	C35A...	80	7.5
Lighting Contactor Coil	C35B...	100	10
Mini XT Relay	XTRM...	29	3.9
LED M22 Indicating Light	M22-L...	0.4	0.4
Intelligent Relay	EZ512...	5	5
Intelligent Relay	EZ719...	10	10
EZ Expansion Module	EZ618...	10	10

Sizing protection for CPTs



Reference Accessories Section on Page 19 for Fuse Holders.

Primary and Secondary Protection



C383FHCC
Single-Pole
Fuse Holder
(Type CC)

CPT Part Number ❶	CPT VA	Primary Two-Pole Breaker	Secondary Two-Pole Breaker	Primary Fuse Size	Secondary Fuse Size
240V Primary: 120V Secondary					
C0025E2A	25	WMZT2CX0	WMZT2CX0	1	1
C0050E2A	50	WMZT2C01	WMZT2C01	1	1
C0075E2A	75	WMZT2CX1	WMZT2C01	3	1
C0100E2A	100	WMZT2C02	WMZT2CX1	3	1
C0150E2A	150	WMZT2C03	WMZT2C02	3	3
C0200E2A	200	WMZT2C04	WMZT2C03	6	3
C0250E2A	250	WMZT2C05	WMZT2C04	6	3
C0300E2A	300	WMZT2C06	WMZT2C04	6	3
C0350E2A	350	WMZT2C07	WMZT2C05	10	3
C0500E2A	500	WMZT2C05	WMZT2C07	6	6
C0750E2A	750	WMZT2C08	WMZT2C10	10	6
C1000E2A	1000	WMZT2C10	WMZT2C15	10	10
480V Primary: 120V Secondary					
C0025E2A	25	WMZT2CX0	WMZT2CX0	1	1
C0050E2A	50	WMZT2CX0	WMZT2C01	1	1
C0075E2A	75	WMZT2C01	WMZT2C01	1	1
C0100E2A	100	WMZT2C01	WMZT2CX1	1	1
C0150E2A	150	WMZT2CX1	WMZT2C02	1	3
C0200E2A	200	WMZT2C02	WMZT2C03	1	3
C0250E2A	250	WMZT2C03	WMZT2C04	1	3
C0300E2A	300	WMZT2C03	WMZT2C04	1	3
C0350E2A	350	WMZT2C04	WMZT2C05	1	3
C0500E2A	500	WMZT2C05	WMZT2C07	1	6
C0750E2A	750	WMZT2C08	WMZT2C10	3	6
C1000E2A	1000	WMZT2C05	WMZT2C15	3	10

❶ Add "FB" to the end of the CPT part number to include a two-pole primary fuse block for rejection type fuses.

Control power selection

1. Determine the output capacity needed to support the components used in the application. First, calculate the total load at steady state (nominal load after inrush). This is done by summing the sealed-in or nominal loads.

$$\text{Nominal Load} = \text{Sealed Load}_1 + \text{Sealed Load}_2 + \dots + \text{Sealed Load}_n$$

For extended operational life of the power supply, increase the calculated nominal load by 20%.

2. Next, calculate the total inrush or surge loads of the components supported by the power supply.

$$\text{Inrush Load} = \text{Inrush Load}_1 + \text{Inrush Load}_2 + \dots + \text{Inrush Load}_n$$

3. Select the power supply based on the available input voltage, nominal load and inrush (surge) load requirements.
4. Verify that the application of the components on the load does not exceed the surge capacity and other specifications of the selected power supply.

Example: Select a 24 Vdc Power Supply with the Following Loads and a 240 Vac Input

Qty	Description	Inrush W	Sealed W	Surge Current	Nominal Current	Total Surge Current	Total Nominal Current
8	XTCE007B10TD Coil	3	3	0.13	0.13	1.00	1.00
4	XTCE018C10TD Coil	12	0.5	0.50	0.02	2.00	0.08
2	Relay	2.6	2.6	0.11	0.11	0.22	0.22
5	Indicating light	1.2	1.2	0.05	0.05	0.25	0.25
						3.47	1.55

Derating for Extended Operation: Total Nominal Current = 1.55 x 120% = 1.86

Selection using data from previous table.

Part Number	Capacity W	Input Voltage	Output Voltage	Nominal Current	Surge Current	Surge Capacity
→ PSG60E	60	100–240 Vac 1-P	24 Vdc	2.5A	3.75A	1 second at 10 second intervals
PSG120E	120	100–240 Vac 1-P	24 Vdc	5A	7.5A	1 second at 10 second intervals
PSG240E	240	100–240 Vac 1-P	24 Vdc	10A	15A	1 second at 10 second intervals

PSG60E has enough nominal and surge current capacity for these components.



Selection Chart

Part Number	Capacity	Input		Output		
		Voltage	Voltage	Nominal Current	Surge Current	Surge Capacity
PSG60E	60W	100–240 Vac single-phase	24 Vdc single-phase	2.5A	3.75A	1 second at 10 second intervals
PSG120E	120W			5A	7.5A	
PSG240E	240W			10A	15A	
PSG480E	480W			20A	30A	
PSG60F	60W	400–500 Vac three-phase	24 Vdc single-phase	2.5A	3.75A	
PSG120F	120W			5A	7.5A	
PSG240F	240W			10A	15A	
PSG480F	480W			20A	30A	

Note: Above 55 degrees C, the PSG should be derated. See catalog CA08102001E for additional information and other specifications.

Common Control Loads

Description	Part Number	Inrush W	Sealed W
7 to 9A XT Contactor Coil	XTCE...B...	3	3
12 to 15A XT Contactor Coil	XTCE...B...	4.5	4.5
18 to 32A XT Contactor Coil	XTCE...C...	12	0.5
40 to 72A XT Contactor Coil	XTCE...D...	24	0.5
80 to 95A XT Contactor Coil	XTCE...F...	90	1.3
115 to 170A XT Contactor Coil	XTCE...G...	149	2.1
Definite Purpose Contactor Coil	C25D...	69	3.1
Lighting Contactor (10 and 20A) Coil	C35...	77	3.4
Mini XT Relay	XTRM...	2.6	2.6
LED M22 Indicating Light	M22-L...	0.4	0.4
Intelligent Relay	EZ512...	2	2
Intelligent Relay	EZ719...	3.5	3.5
EZ Display	EZD-80...	3	3
EZ Expansion Modules	EZ618...	4	4
ELC Programmable Logic Controller	ELC-PV...	5.3	5.3
ELC Expansion Modules	ELC-EX..., -AN..., -TC...	2.2	2.2

Sizing protection for power supplies

Power Supplies









Part Number	Capacity	Input Voltage	Primary Fusing	Class CC Fuse Holder (Qty)	Suggested Power Supply Primary Wire Size
PSG60E	60W	100–240 Vac single-phase	6A or 10A	C383FHCC (2)	14 AWG
PSG120E	120W		6A or 10A	C383FHCC (2)	14 AWG
PSG240E	240W		10A or 16A	C383FHCC (2)	14 AWG
PSG480E	480W		10A or 16A	C383FHCC (2)	14 AWG
PSG60F	60W	400–500 Vac three-phase	6A or 10A	C383FHCC (3)	14 AWG
PSG120F	120W		6A or 10A	C383FHCC (3)	14 AWG
PSG240F	240W		6A or 10A	C383FHCC (3)	14 AWG
PSG480F	480W		6A or 10A	C383FHCC (3)	14 AWG

Note: If the sum of the loads on the secondary of the power supply exceeds the output ratings of the power supply, then secondary overload protection is required.

Wire selection for control circuits

Wire color designation (internal power circuit wiring)

	Black: All ungrounded control circuit conductors operating at the supply voltage
	Red: Ungrounded AC control circuits operating at a voltage less than the supply voltage
	Blue: Ungrounded DC control circuits
	Yellow or orange: Ungrounded control circuits or other wiring, such as for cabinet lighting, that remain energized when the main disconnect is in the OFF position
	White or gray or three white stripes on other than green, blue, orange, or yellow: Grounded AC current-carrying control circuit conductor regardless of voltage
	White with blue stripe: Grounded DC current-carrying control circuit conductor
	White with yellow stripe or white with orange stripe: Grounded AC control circuit current-carrying conductor that remains energized when main disconnect switch is in the OFF position

Wire size for control circuits must be no smaller than 18 AWG, with exception of control circuits for PLC input/outputs. Wire size is determined from Table 38.1 based on the amp rating of the overcurrent protective device for the control circuit or the amp rating of the secondary of the CPT or power supply.

Ampacity of Control Circuit Conductors—Reference Table 38.1

Ampacity, Amperes	Conductor Size	
	AWG	mm ²
10	16	1.3
7	18	0.82
5	20 ②	0.52
3	22 ②	0.32
2	24 ②	0.20
1	26 ②	0.13
0.8	28 ①②	0.08
0.5	30 ①②	0.05

① Where these conductors are contained in a jacketed multi-conductor cable assembly.

② These sizes of conductors are only for connection of control circuits for electronics programmable input/output and static control (having no moving parts).

Logic control—pilot devices selection

Rules for Operator Controls

1. Start buttons and switches should be located either above or to the left of the associated stop button.

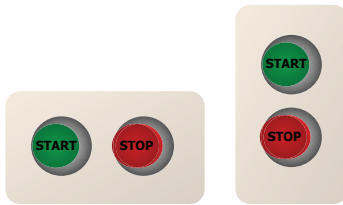





2. Every control panel that includes operator controls should include an emergency stop. This emergency stop should be a mushroom or palm type that is self-latching.













Choosing Operators and Lights

Type	Catalog Number
Flush green momentary button 	M22-D-G
Extended red momentary button 	M22-DP-R
Blue RESET with push rod 	M22-DZ-B-GB14
Twist-to-release E-Stop with 1NO/2NC 	M22-PVT-K12
Two-position maintained selector switch 	M22-WKV
Two-position maintained keyed selector switch 	M22-WRS
Three-position maintained selector switch 	M22-WRK3
Three-position maintained keyed selector switch 	M22-WRS3

Type	Description	Catalog Number
NO contact block 		M22-K10
NC contact block 		M22-K01
LED indicating light 	12–30 Vac/Vdc	
	Yellow	M22-L-Y-W
	Green	M22-L-G-G
	Red	M22-L-R-R
	85–264 Vac/Vdc	
	Yellow	M22-L-Y-230W
	Green	M22-L-G-230G
	Red	M22-L-R-230R
Legend plates 	Blue	M22-L-B-B
	"START"	M22S-ST-GB1
	"STOP"	M22S-ST-GB0
	"OFF ON"	M22S-ST-GB10
	"MAN. AUTO"	M22S-ST-GB11
"HAND O AUTO"	M22-ST-D12	
"MAN. O AUTO"	M22-ST-GB12	

Logic control—relays, timers, and terminal block selection

Image	Type	Catalog Number	Image	Type	Catalog Number
	2NO-2NC 10A relay 120 Vac	XTRM10A22A		30A terminal blocks 6.2 mm wide	XBUT4 (Grey) XBUT4BU (Blue) XBUT4BK (Black) XBUT4WH (White) XBUT4RD (Red)
	2NO-2NC 10A relay 24 Vdc	XTRM10A22TD		Ground terminal block	XBUT4PE
	On-delay timer 0.05s to 60h	XTMT6A60H11B		DIN rail end stop	XBAES35C
	Single-pole terminal block relays	XRU1D120U XRU1D24U		Terminal block jumpers	XBAFBS26—2 pos. XBAFBS36—3 pos. XBAFBS56—5 pos. XBAFBS106—10 pos.
	Four-pole, 15A control relays	D7PF4AA (120 Vac) D7PF4AT1 (24 Vdc)		Terminal block end cover	XBACUT10
	Four-pole control relay socket	D7PAD		Blank marker strip (strip of 10)	XBMZB6
	Multifunction universal timing relay	TRL07		Open three-pole power distribution block 175A	CHDB3213
	DIN rail	XBANS3575P		Finger-safe power distribution block 380A	CHDB330F

Logic control—logic controllers and relays



EZ500 with Display

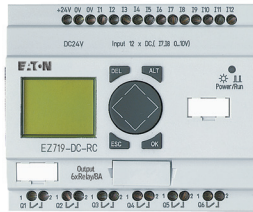

EZ700 with Display



ELC Logic Controller



ELC Power Supply

PLCs and Intelligent Relays

Controller		Expansion Module Options				Power Supply Options						
Catalog Number	Description	Digital Input	Analog Input	Relay Outputs	Catalog Number	Description	100–240 Vac Input Catalog Number	24 Vdc Output (Amps)				
Basic (120 Vac Input)												
EZ512-AC-RC	Intelligent relay with clock and display	8	—	4	—	—	EZ400-POW	1.25				
Basic (24 Vdc Input)												
EZ512-DC-RC	Intelligent relay with clock and display	8	2	4	—	—	EZ400-POW	1.25				
Expanded (120 Vac Input)												
EZ719-AC-RC	Intelligent relay with clock and display	12	—	6	EZ618-AC-RE	120–240 Vac Relay Inputs 12	6	EZ400-POW 1.25				
Expanded (24 Vdc Input)												
EZ719-DC-RC	Intelligent relay with clock and display	12	4	6	EZ618-DC-RE	24 Vdc Relay Inputs 12	6	EZ400-POW 1.25				
Advanced (24 Vdc Input)												
ELC-PV28NNDR	Programmable logic controller that has expandable features with add-on modules	16	—	12	Right Side Module	24 Vdc Inputs	Analog In	Relay Outputs	Analog Transistor Out			
ELC-EX16NNDR					8	—	8	—	—	ELC-PS01	1	
ELC-EX16NNDT					8	—	—	—	8	—	ELC-PS02	2
ELC-AN06AANN					—	4	—	2	—	—		
ELC-TC04ANN					Thermocouple J, K, R, S, T plus 4 analog in							
ELC-MC01					Motion control, 1 axis module							
					Left Side Module							
ELC-COENETM	Ethernet Modbus TCP (master/slave)											

EZ Accessories

- EZSOFT**—Programming software
- EZ-PC-CAB**—PC programming cable
- EZD-80-B**—External display
- EZD-CP4-500**—Display communication module with cable



EZ80-B

ELC Accessories

- ELCSOFT**—ELC programming software
- ELC-GP04**—External graphic panel display
- ELC-CBPCELC1**—PC/graphic panel cable
- ELCSOFTGP**—ELC-GP programming software



ELC-GP04

Sizing the branch protection for a single motor and a control circuit

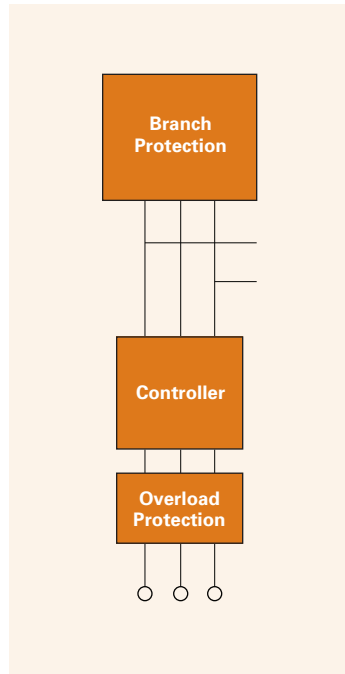

Single Motor Load and Control Circuit with Shared Branch Protection

For single motor load control panel where the branch protective device acts as the main for the panel and the control circuit is tapped off the load side of the device, the branch protective device is sized by the following:

1. Multiply the motor FLA (from Table 50.1 on Page 32) with the following percentage based on the type of protective device from the table at right:
2. Add the full-load current on the primary of the CPT from the table below.
3. Select the closest standard protective device rating.

See Page 8 for selection of the controller and overload protection.

Conductors of a control circuit that are tapped from the load side of a branch circuit device (and where the power voltage is the same as the control voltage—no CPT) shall be protected by overcurrent devices rated not more than as specified in the table at the right.

Branch Circuit Protection

Type	Percent of FLA
Non-time delay fuse and Class CC fuse	Up to 300%
Dual element fuse (time delay) except Class CC	Up to 175%
Inverse-time circuit breaker	Up to 250%
Self-protected combination motor controller	100%
Manual self-protected combination motor controller	100%

Overcurrent Device Ratings for Control Circuit Conductors Tapped from Load Side of Branch Circuit Protective Device—Reference Table 66.4

Conductor Size		Control Circuit Overcurrent Device (Amps)	Branch Circuit Overcurrent Device (Amps)	
AWG	mm ²		Control in Wire Panel	Remote Control
Larger than 14	Larger than 2.1	Equal to wire capacity	400% of wire ampacity	300% of wire ampacity
14	2.1	20	80	60
16	1.3	20	40	20
18	0.82	20	25	20

Note: See table on Page 6 for breaker and fused disconnect part numbers, and Page 19 for fuse holders.

Common Formulas and Conversions

	Direct Current	Single-Phase (AC)	Three-Phase (AC)
Current (I) from HP	$I = \frac{HP \times 746}{V \times \%EFF}$	$I = \frac{HP \times 746}{V \times \%EFF \times PF}$	$I = \frac{HP \times 746}{V \times \%EFF \times PF \times 1.73}$
Current (I) from kW	$I = \frac{kW \times 1000}{V}$	$I = \frac{kW \times 1000}{V \times PF}$	$I = \frac{kW \times 1000}{V \times PF \times 1.73}$
Current (I) from kVA		$I = \frac{kVA \times 1000}{V}$	$I = \frac{kVA \times 1000}{V \times 1.73}$
Horsepower (HP)	$HP = \frac{V \times I \times \%EFF}{746}$	$HP = \frac{V \times I \times \%EFF \times PF}{746}$	$HP = \frac{V \times I \times \%EFF \times PF \times 1.73}{746}$

Voltage Drop Calculations

V	Voltage drop
I	Current
L	Length of cable/wire (ft)
D	Conductor cross section (circular mile)
K	Resistivity of conductor <ul style="list-style-type: none"> • K = 12 for circuits loaded more than 50% of rating (copper) • K = 11 for circuits loaded less than 50% of rating (copper)
Two-wire, single-phase	$V = \frac{2K \times L \times I}{D}$
Three-wire, three-phase	$V = \frac{2K \times L \times I \times 0.866}{D}$

Conversions

1 inch	2.54 cm
3.28 feet	1 meter
1 yard	0.91 meters
1 mile	5,280 feet
1 mile	1.609 kilometers
144 square inches	1 square foot
9 square feet	1 square yard
640 acres	1 square mile
1 cubic foot	7.48 gallons

NEMA/UL/IEC Enclosure Type Cross-Reference—Approximate

NEMA Enclosure Rating	IP10	IP20	IP21	IP22	IP23	IP30	IP31	IP32	IP33	IP40	IP41	IP42	IP43	IP50	IP51	IP52	IP53	IP54	IP55	IP56	IP60	IP61	IP62	IP63	IP64	IP65	IP66	IP67	IP68
1	X	X	X	X	X																								
2	X	X	X	X	X																								
3	X	X	X	X	X	X	X	X	X	X	X	X	X	X	X	X	X	X	X	X	X	X	X	X	X	X	X	X	X
3R	X	X	X	X	X	X	X	X																					
3S	X	X	X	X	X	X	X	X	X	X	X	X	X	X	X	X	X	X	X	X	X	X	X	X	X	X	X	X	X
4	X	X	X	X	X	X	X	X	X	X	X	X	X	X	X	X	X	X	X	X	X	X	X	X	X	X	X	X	X
4X	X	X	X	X	X	X	X	X	X	X	X	X	X	X	X	X	X	X	X	X	X	X	X	X	X	X	X	X	X
6	X	X	X	X	X	X	X	X	X	X	X	X	X	X	X	X	X	X	X	X	X	X	X	X	X	X	X	X	X
6P	X	X	X	X	X	X	X	X	X	X	X	X	X	X	X	X	X	X	X	X	X	X	X	X	X	X	X	X	X
12	X	X	X	X	X	X	X	X	X	X	X	X	X	X	X	X	X	X	X	X	X	X	X	X	X	X	X	X	X
13	X	X	X	X	X	X	X	X	X	X	X	X	X	X	X	X	X	X	X	X	X	X	X	X	X	X	X	X	X

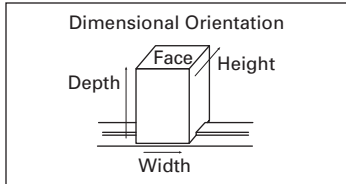

Product Specifications

Protective Devices	Part Number	Tightening Torque (in-lb)			Approximate Dimensions (mm)			Type	Installation Pub Number	
		Lineside	Loadside	Mounting	Height	Width	Depth			
Molded case circuit breakers ①	EGB...	14-10 AWG... 35	14-10 AWG... 35	10	139.7	76.2	75.9	Three-pole	I.L. 29C515C	
	EGE...	8 AWG... 40	8 AWG... 40		139.7	76.2	75.9	Three-pole	I.L. 29C515C	
	EGH...	6-4 AWG... 45	6-4 AWG... 45		139.7	76.2	75.9	Three-pole	I.L. 29C515C	
	EGC...	3-3/0 AWG... 50	3-3/0 AWG... 50		139.7	76.2	75.9	Three-pole	I.L. 29C515C	
	JGE...	4-350 kcmil... 180	4-350 kcmil... 180	10	177.8	104.9	90.7	Three-pole	IL01204006E	
	JGS...				177.8	104.9	90.7	Three-pole	IL01204006E	
	JGH...				177.8	104.9	90.7	Three-pole	IL01204006E	
	JGC...				177.8	104.9	90.7	Three-pole	IL01204006E	
	LGE...	2-500 kcmil (2)... 375	2-500 kcmil (2)... 375	25	257.3	139.2	103.9	Three-pole	IL01207006E	
	LGH...				257.3	139.2	103.9	Three-pole	IL01207006E	
	LGU...				257.3	139.2	103.9	Three-pole	IL01207006E	
	Multiwire terminals	3TA125E3K	70 in-lb	70 in-lb	35	48.0 Incremental				IL01202001E
		3TA125E6K	25 in-lb	25 in-lb	35	48.0 Incremental				IL01202002E
		3TA250FJ3	70 in-lb	70 in-lb	96	81.0 Incremental				IC01204001E
3TA250FJ6		25 in-lb	25 in-lb	96	81.0 Incremental				IC01204002E	
Miniature circuit breakers	WMZT...									
Motor circuit protectors	HMCP...	14-10 AWG... 35 8 AWG... 40 6-4 AWG... 45 3-3/0 AWG... 50	14-10 AWG... 35 8 AWG... 40 6-4 AWG... 45 3-3/0 AWG... 50	28	152.4	105.0	86	Three-pole	IL01211006E	
	HMCP E...	14-10 AWG... 35 8 AWG... 40 6-4 AWG... 45 3-3/0 AWG... 50	14-10 AWG... 35 8 AWG... 40 6-4 AWG... 45 3-3/0 AWG... 50	10	139.7	76.2	75.9	Three-pole	IL29C130D	
Motor protective circuit breaker	FDMP...	14-10 AWG... 35 8 AWG... 40 6-4 AWG... 45 3-4/0 AWG... 50	14-10 AWG... 35 8 AWG... 40 6-4 AWG... 45 3-4/0 AWG... 50	35	152.4	105.0	86.0	Three-pole	IL29C115C	
Fusible disconnects	R4H3030FJ	27 in-lb	27 in-lb	20	116.0	105.0	99.0		N/A	
	R4H3030FCC	27 in-lb	27 in-lb	20	116.0	96.0	83.5		N/A	
	R9J3030FJ and R9J3060FJ	31 in-lb	31 in-lb	20	136.0	149.5	123.0		N/A	
	R9K3100FJ	35.4 in-lb	35.4 in-lb	20	186.0	149.5	123.0		N/A	
	R9L3200FJ	200 in-lb	200 in-lb	20	291.0	195.0	130.0		N/A	
	R9M3400FJ	500 in-lb	500 in-lb	20	390.0	276.0	141.5		N/A	
	R9N3600FJ	500 in-lb	500 in-lb	20	471.0	364.0	250.0		N/A	
Fuse holders	C383FHCC	18-12 AWG... 20 10-8 AWG... 25 18-10 AWG (2)... 25	18-12 AWG... 20 10-8 AWG... 25 18-10 AWG (2)... 25		81.2	17.8	61.0	Single-pole		

① Tightening torques are for standard terminal provided with breaker. For alternative lugs, see the installation publication.

Product Specifications (continued)

Controllers	Part Number	Tightening Torque (in-lb)			Approximate Dimensions (mm)				Type	Installation Pub Number
		Line	Load	Coil	Auxiliary Contacts	Height	Width	Depth		
Motor control	XTSC...BB...	15.0	10.6	10.6	10.6	178.5	45.0	95.7		Pub51176
	XTSC...BC...	15.0	26.6	10.6	10.6	228.8	45.0	124.3		Pub51228
	XTSC...DD...	26.6	29.2	10.6	10.6	284.0	55.0	196.0		Pub51190
	XTFC...BB...	36	10.6	10.6	10.6	209.0	45.0	95.7		Pub51176
	XTFC...BC...	36	26.6	10.6	10.6	266.7	45.0	124.3		Pub51228
	XTFC...DD...	36	29.2	10.6	10.6	312.1	55.0	196.0		Pub51190
	XTCE...B...	10.6	10.6	10.6	10.6	68.0	45.0	75.0		Pub51210
	XTCE...C...	26.6	26.6	10.6	10.6	85.0	45.0	97.4		Pub51211
	XTCE...D...	29.2	29.2	10.6	10.6	104.0	55.0	132.1		Pub51216
	XTCE...F...	123.9	123.9	10.6	10.6	170.0	90.0	160.0		Pub51188
	XTCE...G...	123.9	123.9	10.6	10.6	170.0	90.0	160.0		Pub51188
	XTOB...BC1	—	16.0	—	7–10.6	49.8 incremental	45.0	88.4		Pub51210
	XTOB...CC1	—	16.0	—	7–10.6	51.4 incremental	45.0	105.3		Pub51211
	XTOB...DC1	—	31.0	—	7–10.6	70 incremental	60.0	93.6		Pub51216
	XTOB...GC1	—	88.5	—	7–10.6	107 incremental	118.0	134		Pub51188
	XTCEXF...	—	—	—	10.6	—	—	41.2 incremental		Pub51211 or Pub51216
	XTCEXS...	—	—	—	10.6	—	10.5 incremental	—		Pub51216 or Pub51188
	XTPAXF...	—	—	—	10.6	—	—	—		Pub51198
	XTPAXPCB	Not required	—	—	—	—	—	—		Pub51176
	XTPAXLSA	36	—	—	—	30.5 incremental	—	—		—
Definite purpose	C25DR...	12–14 AWG 15 in-lb 10 AWG 25 in-lb 8 AWG 40 in-lb 4–6 AWG 45 in-lb								

Product Specifications (continued)

Power Conversion	Part Number	Tightening Torque (in-lb)		Approximate Dimensions (mm)			Type	Installation Pub Number
		Primary	Secondary	Height	Width	Depth		
Control power transformers	C0025E2A	16	16	65.0	76.0	64.0	—	
	C0050E2A	16	16	65.0	76.0	76.0	—	
	C0075E2A	16	16	65.0	76.0	89.0	—	
	C0100E2A	16	16	73.0	86.0	86.0	—	
	C0150E2A	16	16	81.0	95.0	102.0	—	
	C0200E2A	16	16	97.0	114.0	102.0	—	
	C0250E2A	16	16	97.0	114.0	111.0	—	
	C0300E2A	16	16	97.0	114.0	121.0	—	
	C0350E2A	16	16	97.0	114.0	133.0	—	
	C0500E2A	30	30	121.0	133.0	140.0	—	
	C0750E2A	30	30	121.0	133.0	178.0	—	
C1000E2A	30	30	144.0	171.0	164.0	—		
Power supplies	PSG60E	6.94–8.68	6.94–8.68	125.0	32.0	120.5	—	IL00912001E
	PSG60F	10.41–13.89	10.41–13.89	126.5	70.0	111.4	—	IL00912005E
	PSG120E	6.94–8.68	6.94–8.68	126.5	50.0	115.0	—	IL00912002E
	PSG120F	10.41–13.89	10.41–13.89	126.5	70.0	111.3	—	IL00912006E
	PSG240E	6.94–8.68	6.94–8.68	126.5	85.0	118.5	—	IL00912003E
	PSG240F	10.41–13.89	10.41–13.89	126.5	85.0	120.5	—	IL00912007E
	PSG480E	10.41–13.89	10.41–13.89	126.5	160.0	111.4	—	IL00912004E
	PSG480F	10.41–13.89	10.41–13.89	126.5	160.0	111.4	—	IL00912008E

Type	Part Number	Tightening Torque (in-lb)		Mounting	Approximate Dimensions (mm)			Type	Installation Pub Number
		Lineside	Loadside		Height	Width	Depth		
Logic controllers	EZ512...	5.3	5.3	—	110.0	71.5	58.0	—	MN05013003E
	EZ719...	5.3	5.3	—	110.0	107.5	58.0	—	MN05013003E
	EZ618...	5–7	5–7	—	110.0	107.5	58.0	—	IL05013009E
	EZ400...	5–7	5–7	—	110.0	71.5	56.5	—	IL05013008E
	ELC-PV...	22–16 AWG... 1.7	22–16 AWG... 1.7	—	96.0	70.0	60.0	—	IL05001004E
	ELC-EX16NNDR	22–16 AWG... 1.7	22–16 AWG... 1.7	—	96.0	25.2	60.0	—	IL05003004E
	ELC-EX16NNDT	22–16 AWG... 1.7	22–16 AWG... 1.7	—	96.0	25.2	60.0	—	IL05003004E
	ELC-AN06AANN	22–16 AWG... 1.7	22–16 AWG... 1.7	—	96.0	25.2	60.0	—	IL05003003E
	ELC-TC04ANNN	1.7	1.7	—	96.0	25.2	60.0	—	IL05003009E
	ELC-MC01	22–16 AWG... 1.7	22–16 AWG... 1.7	—	96.0	25.2	60.0	—	IL05003023E
	ELC-COENETM	—	—	—	96.0	33.0	60.0	—	MN05006001E
	ELC-PS01	4.3–6.9	4.3–6.9	—	96.0	36.5	60.0	—	IL05003007E
	ELC-PS02	4.3–6.9	4.3–6.9	—	96.0	55.0	60.0	—	IL05003007E

Product Specifications (continued)

Logic Circuit Components	Part Number	Tightening Torque (in-lb)				Approximate Dimensions (mm)					Installation Pub Number
		Line	Load	Mounting	Coil	Height	Width	Depth	Type		
Pushbuttons, switches pilot lights	M22...	7.1	—	17.7	—	—	—	—	—	—	IL04716001E
	M22...	7.1	—	17.7	—	—	—	—	—	—	—
Relays	XTRM...	10.6	—	—	10.6	58.0	45.0	54.0	—	—	Pub51219
	XTMT...	10.6	—	—	10.6	58.0	45.0	54.0	—	—	Pub51245
	TRL07	8.8	—	—	8.8	87.0	17.5	60.0	—	—	IL04910002E
	D7...	7–8	—	—	7–8	79.7	49.9	70.0	—	—	—
Terminal blocks	XBUT4...	5.3–7.1	—	—	—	47.5	6.2	46.9	—	—	Pub51473
	XBAE...	5.3–7.1	—	—	—	47.5	6.2	46.9	—	—	Pub51473
	XBAF...	Not required	—	—	—	—	—	—	—	—	Pub51473
	CHDB3213	2/0–8 AWG... 120	4–6 AWG... 35 8 AWG... 25 10–14... 20	—	—	101.6	131.8	84.3	—	—	—
	CHDB330F	500–6 AWG... 500	2–3 AWG... 50 4–6 AWG... 45 8 AWG... 40 10–14 AWG... 35	—	—	118.4	39.1	72.9	—	—	—

With the permission of Underwriters Laboratories, Inc., material is reproduced from UL Standard 508A, Industrial Control Panels, which is copyrighted by Underwriters Laboratories, Inc., Northbrook, Illinois. While use of this material has been authorized, UL shall not be responsible for the manner in which the information is presented, nor for any interpretations thereof. UL's approval to use this information does not imply or warrant that any associated products or materials in this publication are UL Listed. For more information on UL or to purchase standards, please visit our Standards website at www.comm-2000.com or call 1-888-853-3503.



Eaton
 1000 Eaton Boulevard
 Cleveland, OH 44122
 United States
 Eaton.com

© 2015 Eaton
 All Rights Reserved
 Printed in USA
 Publication No. MZ083018EN / Z16285
 February 2015

Eaton is a registered trademark.

All other trademarks are property
 of their respective owners.

Follow us on social media to get the
 latest product and support information.

